

QDLASER

QLF063A-P120/QLF063D-P120

660 nm 120mW FP LASER TO-CAN

C00063-03 June 2014



1. DESCRIPTION

The QLF063A-P120 is a 660 nm quantum well laser device designed for high output power application. The laser diode is mounted into a TO-56 header including a monitor PD and hermetic sealed with a flat glass cap.

2. FEATURES

- 660 nm FP-LD
- $\Phi 5.6\text{mm}$ TO-CAN package
- High output power of 120mW and high slope efficiency
- Including monitor PD
- Two types of pin assignments: anode common type (QLF063A-P120)/cathode common type (QLF063D-P120)

3. APPLICATIONS

- Industrial laser markers
- Measuring instruments
- Life science applications

4. ABSOLUTE MAXIMUM RATING

(CW operation, $T_c = 25^\circ\text{C}$, unless otherwise specified)

PARAMETER	SYMBOL	RATING	UNIT
Optical output power	P_o	130	mW
LD reverse voltage	V_{RLD}	2	V
PD reverse voltage	V_{RPD}	30	V
Operation temperature	T_c	-10 to 60	$^\circ\text{C}$
Storage temperature	T_{stg}	-40 to 85	$^\circ\text{C}$

5. OPTICAL AND ELECTRICAL CHARACTERISTICS

($T_c = 25^\circ\text{C}$, unless otherwise specified)

PARAMETER	SYMBOL	TEST CONDITION	MIN	TYP	MAX	UNIT
Threshold current	I_{th}	CW	-	55	70	mA
Operation current	I_{op}	CW, $P_o=120\text{ mW}$	-	170	220	mA
Operation voltage	V_{op}	CW, $P_o=120\text{ mW}$	-	2.5	3.0	V
Slope efficiency	η	CW, $P_o=5 - 120\text{ mW}$	0.8	1.1	-	W/A
Monitor current	I_m	CW, $P_o=120\text{ mW}$, $V_{RD}=5\text{ V}$	60	310	720	μA
Peak wavelength	λ_p	CW, $P_o=120\text{ mW}$	655	660	665	Nm
Far filed pattern horizontal	θ_h	CW, $P_o=120\text{ mW}$	-	10	-	deg.
Far filed pattern vertical	θ_v	CW, $P_o=120\text{ mW}$	-	14	-	deg.

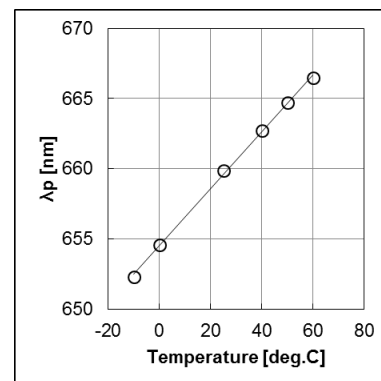
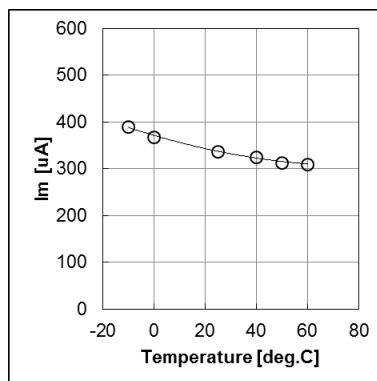
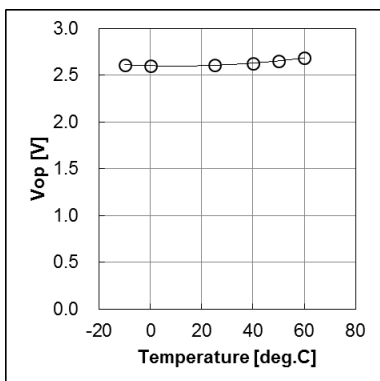
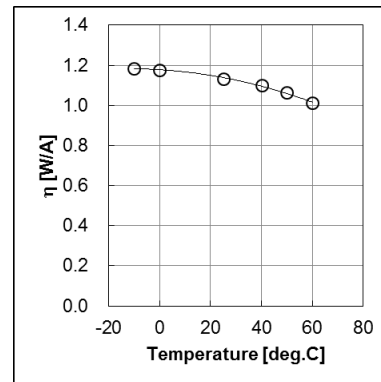
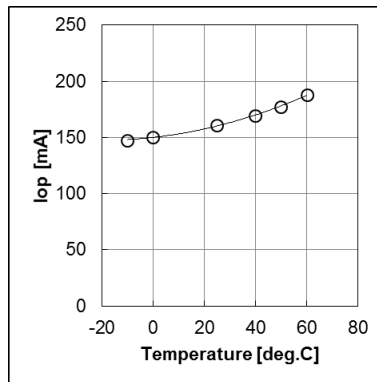
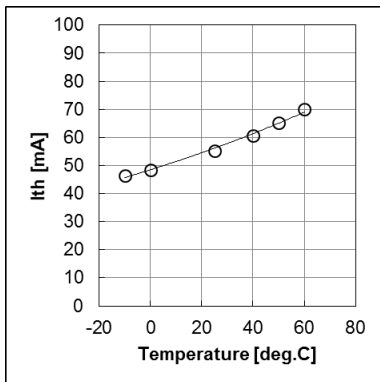

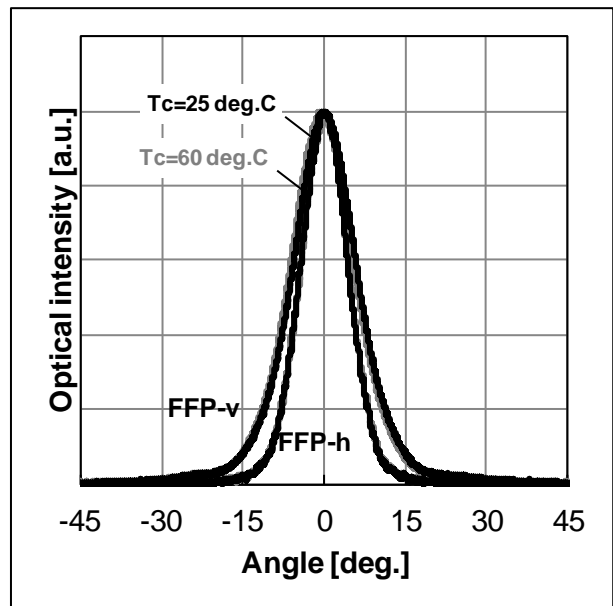
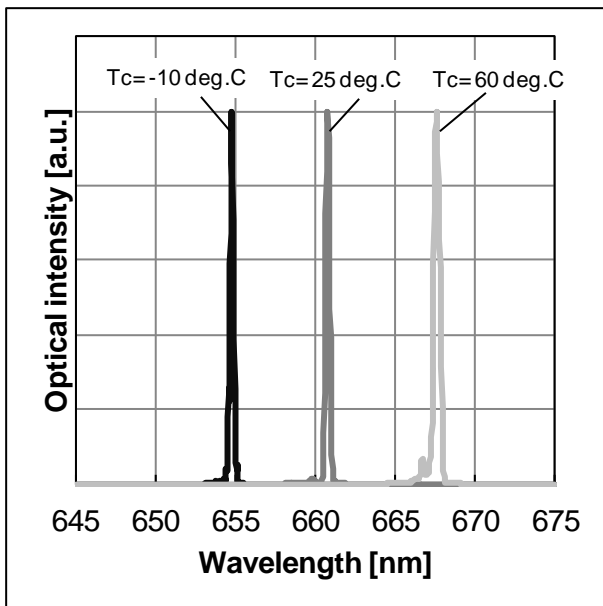
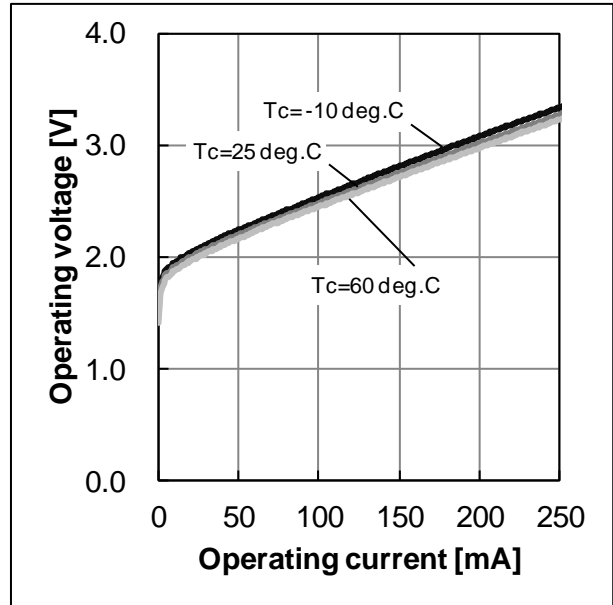
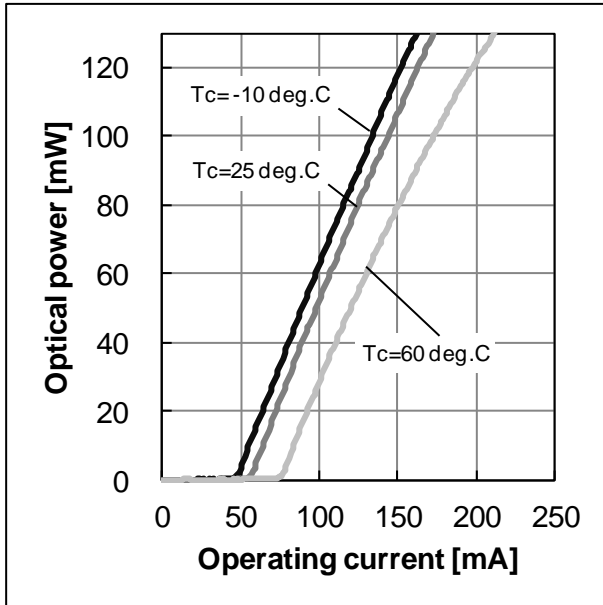

6. OUTLINE DRAWINGS

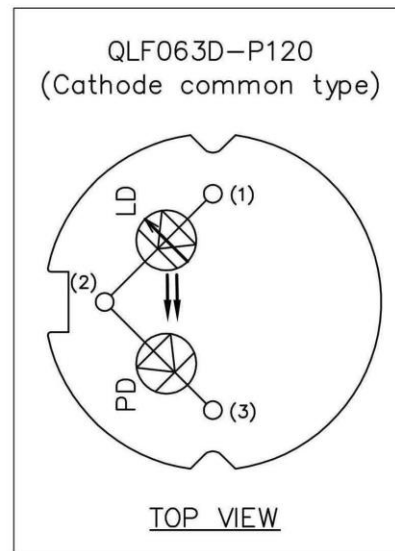
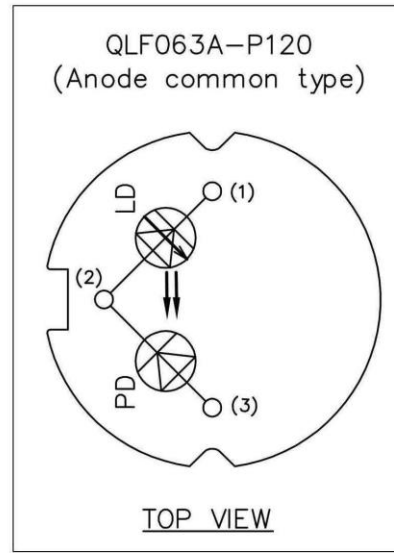
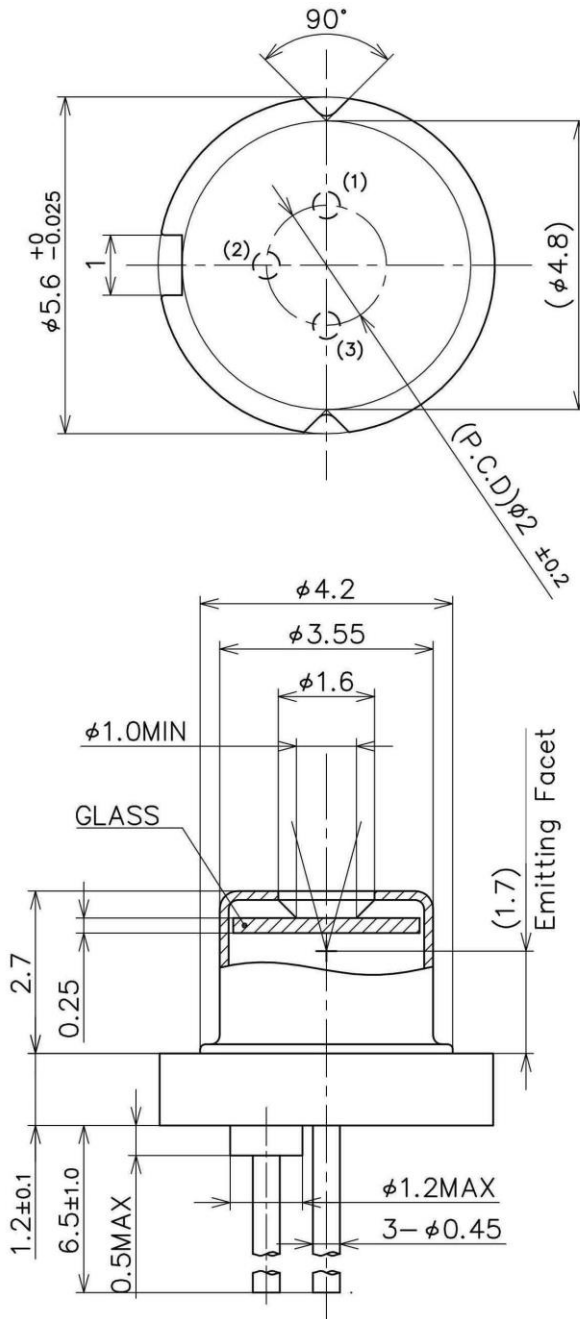

All Dimensions in millimeters

7. NOTICE

- Safety Information

This product is classified as Class 3B laser product, and complies with 21 CFR Part 1040.10.

Please do not take a look laser lighting in operations since laser devices may cause troubles to human eyes.

Please do not eat, burn, break and make chemical process of the products since they contain GaAs material.

- Handling products

Semiconductor lasers are easily damaged by external stress such as excess temperature and ESD.

Please pay attention to handling products, and use within range of maximum ratings.

QD Laser takes no responsibility for any failure or unusual operation resulting from improper handling, or unusual physical or electrical stress.

- RoHS

This product conforms to RoHS compliance related EU Directive 2011/65/EU.

QD Laser, Inc.

Contact : info@qdlaser.com <http://www.qdlaser.com>

Copyright 2012 All Rights Reserved by QD Laser, Inc.

Keihin Bldg. 1F 1-1 Minamiwatarida-cho, Kawasaki-ku, Kawasaki, Kanagawa Zip 210-0855 Japan

All company or product names mentioned herein are trademarks or registered trademarks of their respective owners. Information provided in this data sheet is accurate at time of publication and is subject to change without advance notice.